

KUNSTSTOFF PLASTIQUE

WELLPLATTEN, FLACHPLATTEN
PLAQUES ONDULÉES, PLAQUES PLATES

DOPPEL- UND 3-STEGLATTEN
ÉLÉMENTS À DOUBLE ET TRIPLE PAROIS

PROFILE + BEFESTIGUNGSMATERIAL
PROFILÉS ET MATÉRIEL DE FIXATION



grischa silva  Holz
Lenn
Legno

- Zaunbau
- Gartenhäuser
- Sichtschutz
- Terrassenböden

www.grischa-silva.ch

Waldau - 7302 Landquart / Tel. 081 322 60 05

Die wichtigsten Informationen über Kunststoffe auf einen Blick!

Tableau synoptique des informations les plus importantes sur plastiques!



UV-aktives Material. Bedeutet u. a. auch gutes Gedeihen von Pflanzen!
Matière perméable aux rayons UV – c.-à.-d. favorable à la pousse des plantes.



UV-beständiges Material. Nichts versprödet, witterungsbeständig!
Matière résistante aux rayons UV. Pas de fragilité, résistante aux intempéries.



Thermoplaste nicht unter direkter Sonneneinstrahlung stapeln und lagern. Kann sofort zu Verformung und frühzeitiger Alterung führen.
Prière de ne pas stocker les matières thermoplastiques à une place directement ensoleillée afin d'éviter les déformations et le vieillissement prématuré.



Kunststoff lebt! Bei Montagen von Thermoplasten die Dilatation beachten. Dehnungen bis zu 3,5 mm pro m sind bei grösseren Temperaturunterschieden möglich.
En cas d'assez grandes différences de température il est possible que la matière se dilate jusqu'à 3,5 mm par mètre.



Material verträgt maximale Dauertemperaturen von bis zu 60°C. Unter 10°C wird das Material härter, ist schlagempfindlicher und mit grösserer Sorgfalt zu verarbeiten.
Matière résistante jusqu'à une température maximum de 60°C. En-dessous de 10°C, le matériel devient plus dur, résiste moins aux coups et doit être traité avec plus de soins.



Schlagzäher Kunststoff, wobei die Schlagfestigkeit bei niedrigen Temperaturen nachlässt.
Plastique d'une grande résilience diminuant aux températures basses.



Material kann mit handelsüblichen Bohrern bearbeitet werden.
Matière peut être traitée par perceuses d'usage.



Mit Silikon oder Klebstoffen klebbar und verbindbar. Bitte Anwenderhinweise beachten.
Assembler par substances adhésives ou bien silicone. Prière de consulter les informations pour utilisateurs.



Material mit Holzbearbeitungswerkzeug bearbeitbar.
Matière usinable par outils à travailler le bois.



Material mit einfachstem Holzbearbeitungswerkzeug bearbeitbar.
Matière usinable par outils à travailler le bois.



Zuschneiden mittels Trennscheibe möglich.
Couper par meules à tronçonner.



Material mit Eisenbearbeitungswerkzeug bearbeitbar.
Matière usinable par outils à travailler le fer.



Reinigung nur mit nicht aggressiven Reinigungsmitteln. Empfohlen wird handelsübliche Seifenlauge.
Prière de ne pas utiliser un détergent caustique. Nous vous recommandons une lessive d'usage.



Das Material ist kalt abbiegbar.
Matière peut être cintrée ou pliée à froid.



Recycling. Wiederverarbeitung von altem oder defektem Material möglich.
Recyclage – Retraitement de matière vieille ou bien endommagée possible.



Material nur mit zylindrisch zugeschnittenem Bohrer bearbeiten. In Randnähe besteht Ausreisssgefahr.
Prière de travailler la matière seulement au moyen d'une perceuse cylindrique. Aux bords des laques risque de ruptures.

INHALT · SOMMAIRE

4

7

Polyesterplatten / *Plaques en polyester*

5

16

20

PVC

6

12–13

19

Acrylglas / *Verre acrylique*

8–10

Kunstglas / *Verre artificiel*

11

Plasticlair PET / *Plasticlair*

14–15

Hartschaumplatten / *Plaques expense*

17–18

Polycarbonat / *Polycarbonate*

21–28

31

Zubehör / *Accessoires*

29–30

Bitumen / *Bitumes*

POLYESTERPLATTEN

PLAQUES EN POLYESTER

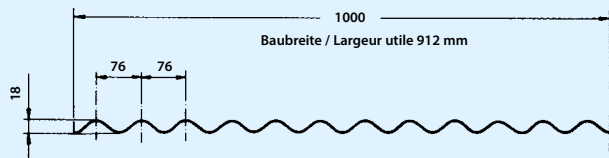

Polyesterplatten 76/18
Plaques en polyester 76/18 375 g

Art.-Nr. No d'article	Farbe Couleur	Länge mm Longueur mm	Breite mm Largeur mm	UVP/Stk. PVC/pce
3000.045	natur / nature	1000	1000	13.95
3000.050	natur / nature	1500	1000	20.90
3000.055	natur / nature	2000	1000	26.90
3000.060	natur / nature	2500	1000	33.90
3000.064	grün / vert	1000	1000	13.95
3000.065	grün / vert	1500	1000	20.90
3000.070	grün / vert	2000	1000	26.90
3000.075	grün / vert	2500	1000	33.90
3000.079	bronze	1000	1000	13.95
3000.080	bronze	1500	1000	20.90
3000.085	bronze	2000	1000	26.90
3000.090	bronze	2500	1000	33.90



Polyesterplatten 95/37
Plaques en polyester 95/37

Art.-Nr. No d'article	Farbe Couleur	Länge mm Longueur mm	Breite mm Largeur mm	UVP/Stk. PVC/pce
3150.080	natur / nature	2000	950	54.90



PVC

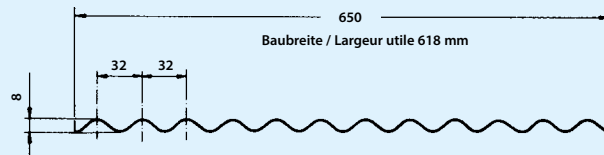

PVC-Platten Kleinwellung 8/32
Plaques PVC à petites ondes 8/32

Art.-Nr. No d'article	Farbe Couleur	Länge mm Longueur mm	Breite mm Largeur mm	UVP/Stk. PVC/pce
3070.005	glasklar / clair	1000	650	9.95
3070.010	grün / vert	1000	650	9.95
3070.015	azur / azuré	1000	650	9.95

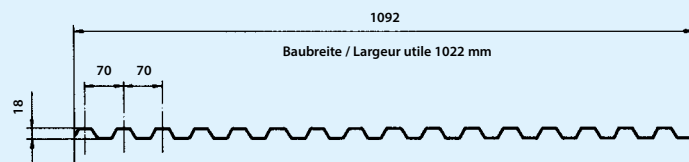

Spundwandprofilplatten PVC S 70/18
Plaques ondulés en PVC S 70/18

Art.-Nr. No d'article	Farbe Couleur	Länge mm Longueur mm	Breite mm Largeur mm	UVP/Stk. PVC/pce
3050.005	glasklar / clair	1500	1092	29.90
3050.010	glasklar / clair	2000	1092	39.90
3050.015	glasklar / clair	2500	1092	47.90
3050.020	azur / azuré	1500	1092	26.90
3050.025	azur / azuré	2000	1092	31.90
3050.030	azur / azuré	2500	1092	39.90
3050.035	rauchbraun / brun fumé	2500	1092	44.90

Wellplatten Prisma PVC S 76/18
Plaques ondulés prisme en PVC S 76/18

Art.-Nr. No d'article	Farbe Couleur	Länge mm Longueur mm	Breite mm Largeur mm	Dicke mm Epaisseur mm	UVP/Stk. PVC/pce
3070.101	bronze / bronze	2000	1030	2.5	84.90



ACRYLGLAS · VERRE ACRYLIQUE

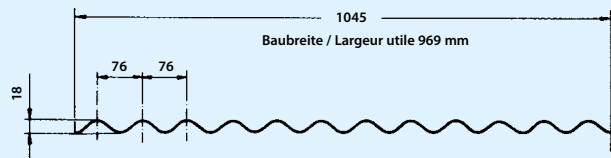

Acryl-Wellplatten «Wabe» 76/18, Stärke 3,0 mm
Plaques acryliques ondulé 76/18 structuré, Epaisseur 3,0 mm

Art.-Nr. No d'article	Farbe Couleur	Länge mm Longueur mm	Breite mm Largeur mm	UVP/Stk. PVC/pce
3000.300	klar / clair	2000	1045	109.00
3000.305	klar / clair	2500	1045	139.00
3000.310	klar / clair	3000	1045	179.00
3000.319	klar / clair	4000	1045	219.00
3000.325	klar / clair	6000	1045	339.00
3000.301	braun / brun	2000	1045	109.00
3000.306	braun / brun	2500	1045	139.00
3000.311	braun / brun	3000	1045	179.00
3000.318	braun / brun	4000	1045	219.00
3000.326	braun / brun	6000	1045	339.00



Abbildung: Acryl-Wellplatte «Wabe» braun
Image: Plaque acrylique ondulé brun

POLYESTERPLATTEN PLAQUES EN POLYESTER

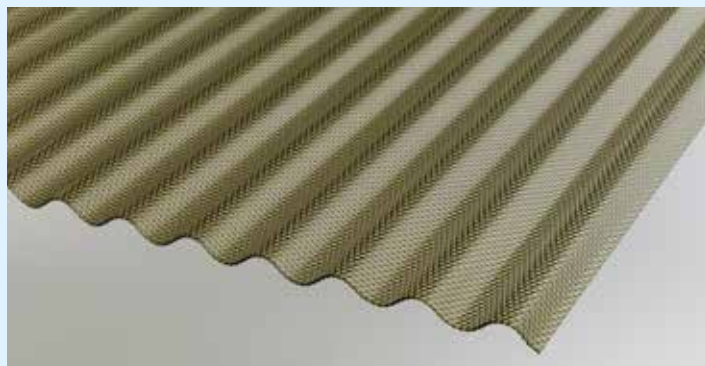
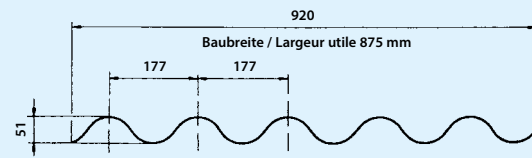

Polyesterplatten Eternitwellung 177/51
Plaques en polyester Ondulation Eternit 177/51 600 g

Art.-Nr. No d'article	Farbe Couleur	Länge mm Longueur mm	Breite mm Largeur mm	UVP/Stk. PVC/pce
3000.041	natur / nature	2000	920	59.90
3000.047	natur / nature	2500	920	74.90

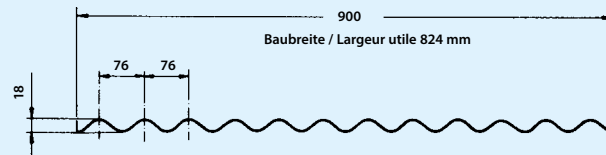

Poly-Clair Polyesterplatten 76/18, Qualität 690 g, beidseitig Gelcoat
Qualité 690 g, les 2 côtés Gelcoat

Art.-Nr. No d'article	Farbe Couleur	Länge mm Longueur mm	Breite mm Largeur mm	UVP/Stk. PVC/pce
3000.150	natur / nature	1000	900	29.90
3000.155	natur / nature	1500	900	42.90
3000.160	natur / nature	2000	900	59.90
3000.165	natur / nature	2500	900	74.90
3000.170	natur / nature	3000	900	84.90
3000.175	natur / nature	3500	900	99.90
3000.180	natur / nature	4000	900	115.00
3000.185	natur / nature	5000	900	139.00
3000.190	natur / nature	6000	900	169.00



KUNSTGLAS · VERRE ARTIFICIEL

Kunstglas reflexfrei, 2 mm
verre artificiel antireflet, 2 mm

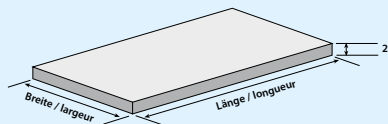

Art.-Nr. No d'article	Farbe Couleur	Länge mm Longueur mm	Breite mm Largeur mm	UVP/Stk. PVC/pce
3100.001	glasklar / transparent	180	130	2.75
3100.025	glasklar / transparent	180	240	3.75
3100.005	glasklar / transparent	240	300	4.95
3100.030	glasklar / transparent	300	400	7.50
3100.035	glasklar / transparent	400	500	11.95
3100.010	glasklar / transparent	480	600	14.95
3100.015	glasklar / transparent	500	700	17.50
3100.020	glasklar / transparent	1000	700	35.90



Kunstglas flach, 2,5 mm
Verre artificiel plat, 2,5 mm

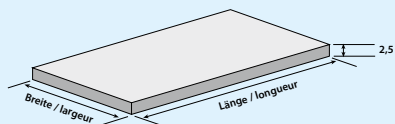

Art.-Nr. No d'article	Farbe Couleur	Länge mm Longueur mm	Breite mm Largeur mm	UVP/Stk. PVC/pce
3120.015	glasklar / clair	500	1000	19.95
3120.010	glasklar / clair	1000	1000	37.90
3120.005	glasklar / clair	2000	1000	74.90
3120.094	milch / opale	500	1000	19.95
3120.095	milch / opale	1000	1000	37.90
3120.096	milch / opale	2000	1000	74.90



KUNSTGLAS · VERRE ARTIFICIEL

Kunstglas flach, 5,0 mm
Verre artificiel plat, 5,0 mm

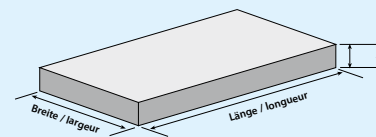

Art.-Nr. No d'article	Farbe Couleur	Länge mm Longueur mm	Breite mm Largeur mm	UVP/Stk. PVC/pce
3120.030	glasklar / clair	500	1000	32.90
3120.025	glasklar / clair	1000	1000	64.90
3120.020	glasklar / clair	2000	1000	139.00
3120.027	milch / opale	500	1000	32.90
3120.028	milch / opale	1000	1000	64.90
3120.029	milch / opale	2000	1000	139.00



Kunstglas Tropfen, 5,0 mm
Verre artificiel «Tropfen», 5,0 mm

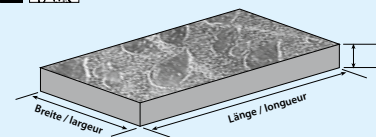

Art.-Nr. No d'article	Farbe Couleur	Länge mm Longueur mm	Breite mm Largeur mm	UVP/Stk. PVC/pce
3119.990	glasklar / clair	500	1000	32.90
3119.980	glasklar / clair	1000	1000	64.90
3119.970	glasklar / clair	2000	1000	139.00



Kunstglas Tropfen, 2,5 mm
Verre artificiel «Tropfen», 2,5 mm

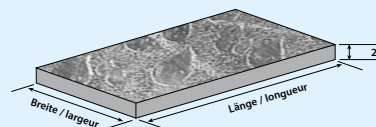

Art.-Nr. No d'article	Farbe Couleur	Länge mm Longueur mm	Breite mm Largeur mm	UVP/Stk. PVC/pce
3120.018	glasklar / clair	500	1000	19.95
3120.012	glasklar / clair	1000	1000	37.90
3120.007	glasklar / clair	2000	1000	74.90



KUNSTGLAS · VERRE ARTIFICIEL

Kunstglas strukturiert, 2,5 mm
Verre artificiel structuré, 2,5 mm

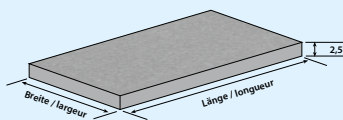

Art.-Nr. No d'article	Farbe Couleur	Länge mm Longueur mm	Breite mm Largeur mm	UVP/Stk. PVC/pce
3120.060	glasklar / clair	500	1000	19.95
3120.055	glasklar / clair	1000	1000	37.90
3120.050	glasklar / clair	2000	1000	74.90



Kunstglas Baumrinde, 5,0 mm
Verre artificiel écorce d'arbre, 5,0 mm

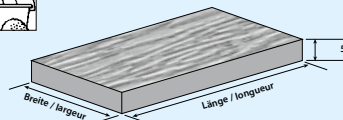

Art.-Nr. No d'article	Farbe Couleur	Länge mm Longueur mm	Breite mm Largeur mm	UVP/Stk. PVC/pce
3120.032	braun / brun	500	1000	32.90
3120.033	braun / brun	1000	1000	64.90
3120.034	braun / brun	2000	1000	139.00
3120.047	glasklar / clair	500	1000	32.90
3120.048	glasklar / clair	1000	1000	64.90
3120.049	glasklar / clair	2000	1000	139.00



Kunstglas Baumrinde, 2,5 mm
Verre artificiel écorce d'arbre, 2,5 mm

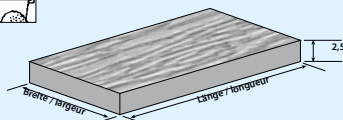

Art.-Nr. No d'article	Farbe Couleur	Länge mm Longueur mm	Breite mm Largeur mm	UVP/Stk. PVC/pce
3120.077	glasklar / clair	500	1000	19.95
3120.078	glasklar / clair	1000	1000	37.90
3120.079	glasklar / clair	2000	1000	74.90
3120.091	braun / brun	500	1000	19.95
3120.092	braun / brun	1000	1000	37.90
3120.093	braun / brun	2000	1000	74.90



PLASTICLAIR PET · PLASTICLAIR

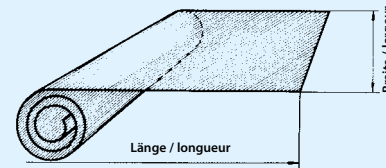

Plasticlair 0,7 mm glasklar, in Rollen, PET
Plasticlair 0,7 mm transparent, en rouleaux, PET

Art.-Nr. No d'article	Farbe Couleur	Länge m Longueur m	Breite m Largeur m	UVP/m PVC/m
3060.006	natur / nature	50,00	1,00	14.95
3060.011	natur / nature	50,00	1,25	18.95



Abbildung: Plasticlair-Rolle
Image: Plasticlair en rouleau

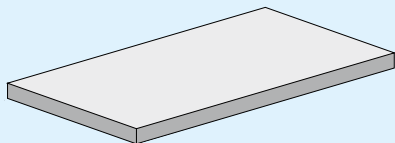

Acryl-Glas extrudiert, flach
Verre acrylique – qualité extrudé

Art.-Nr. No d'article	Farbe Couleur	Dicke mm Epaisseur mm	Masse mm Mesures mm	UVP/Stk. PVC/pce
3110.005	glasklar / clair	2	250 × 500	7.95
3110.010	glasklar / clair	2	500 × 500	15.95
3110.020	glasklar / clair	2	750 × 500	23.90
3111.041	glasklar / clair	2	3050 × 2050	239.00
3110.021	glasklar / clair	2	Zuschnitt / Coupe	74.90 / m ²
3110.025	glasklar / clair	3	250 × 500	9.95
3110.030	glasklar / clair	3	500 × 500	19.95
3110.035	glasklar / clair	3	750 × 500	29.90
3110.040	glasklar / clair	3	1000 × 500	38.90
3110.045	glasklar / clair	3	1250 × 500	48.90
3110.046	glasklar / clair	3	1500 × 500	58.90
3110.047	glasklar / clair	3	1000 × 745	58.90
3110.050	glasklar / clair	3	1500 × 745	84.90
3111.043	glasklar / clair	3	3050 × 2050	349.00
3110.051	glasklar / clair	3	Zuschnitt / Coupe	89.90 / m ²

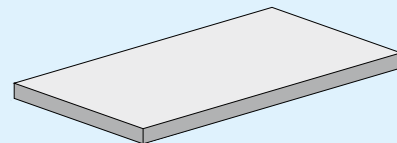

Acryl-Glas extrudiert, flach
Verre acrylique – qualité extrudé

Art.-Nr. No d'article	Farbe Couleur	Dicke mm Epaisseur mm	Masse mm Mesures mm	UVP/Stk. PVC/pce
3111.044	glasklar / clair	4	3050 × 2050	459.00
3111.054	glasklar / clair	4	Zuschnitt / Coupe	99.90 / m ²
3110.055	glasklar / clair	5	250 × 500	13.95
3110.060	glasklar / clair	5	500 × 500	27.90
3110.065	glasklar / clair	5	750 × 500	41.90
3110.070	glasklar / clair	5	1000 × 500	54.90
3110.075	glasklar / clair	5	1250 × 500	69.90
3110.079	glasklar / clair	5	1000 × 745	79.90
3110.076	glasklar / clair	5	1500 × 500	79.90
3110.080	glasklar / clair	5	1500 × 745	119.00
3111.045	glasklar / clair	5	3050 × 2050	569.00
3110.081	glasklar / clair	5	Zuschnitt / Coupe	119.00 / m ²
3111.046	glasklar / clair	6	3050 × 2050	669.00
3111.056	glasklar / clair	6	Zuschnitt / Coupe	139.00 / m ²
3111.048	glasklar / clair	8	3050 × 2050	729.00
3111.049	glasklar / clair	8	Zuschnitt / Coupe	169.00 / m ²
3111.070	glasklar / clair	10	3050 × 2050	999.00
3111.071	glasklar / clair	10	Zuschnitt / Coupe	219.00 / m ²



HARTSCHAUMPLATTEN PLAQUES EXPENSE

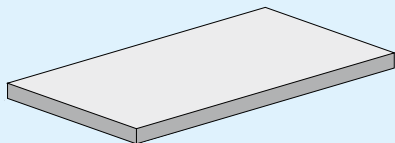

PVC-Hartschaumplatten
Plaques expense en PVC

Art.-Nr. No d'article	Farbe Couleur	Dicke mm Epaisseur mm	Masse mm Mesures mm	UVP/Stk. PVC/pce
3080.200	gelb /jaune	3	500 × 250	4.50
3080.202	gelb /jaune	3	500 × 500	8.50
3080.204	gelb /jaune	3	500 × 1000	15.95
3080.206	gelb /jaune	3	500 × 1250	18.95
3080.208	gelb /jaune	3	500 × 1500	23.90
3080.210	grün /vert	3	500 × 250	4.50
3080.212	grün /vert	3	500 × 500	8.50
3080.214	grün /vert	3	500 × 1000	15.95
3080.216	grün /vert	3	500 × 1250	18.95
3080.218	grün /vert	3	500 × 1500	23.90
3080.220	blau /bleu	3	500 × 250	4.50
3080.222	blau /bleu	3	500 × 500	8.50
3080.224	blau /bleu	3	500 × 1000	15.95
3080.226	blau /bleu	3	500 × 1250	18.95
3080.228	blau /bleu	3	500 × 1500	23.90
3080.230	rot /rouge	3	500 × 250	4.50
3080.232	rot /rouge	3	500 × 500	8.50
3080.234	rot /rouge	3	500 × 1000	15.95
3080.236	rot /rouge	3	500 × 1250	18.95
3080.238	rot /rouge	3	500 × 1500	23.90



HARTSCHAUMPLATTEN PLAQUES EXPENSE

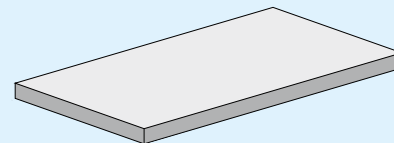

PVC-Hartschaumplatten
Plaques expense en PVC

Art.-Nr. No d'article	Farbe Couleur	Dicke mm Epaisseur mm	Masse mm Mesures mm	UVP/Stk. PVC/pce
3080.240	weiss /blanc	3	500 × 250	4.50
3080.242	weiss /blanc	3	500 × 500	8.50
3080.244	weiss /blanc	3	500 × 1000	15.95
3080.246	weiss /blanc	3	500 × 1250	18.95
3080.248	weiss /blanc	3	500 × 1500	23.90
3080.250	grau /gris	3	500 × 250	4.50
3080.252	grau /gris	3	500 × 500	8.50
3080.254	grau /gris	3	500 × 1000	15.95
3080.256	grau /gris	3	500 × 1250	18.95
3080.258	grau /gris	3	500 × 1500	23.90
3080.260	schwarz /noir	3	500 × 250	4.50
3080.262	schwarz /noir	3	500 × 500	8.50
3080.264	schwarz /noir	3	500 × 1000	15.95
3080.266	schwarz /noir	3	500 × 1250	18.95
3080.268	schwarz /noir	3	500 × 1500	23.90



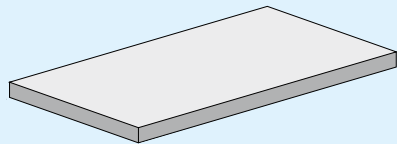

PVC-Flachplatten opak geschäumt
Plaques opaques en PVC

Art.-Nr. No d'article	Farbe Couleur	Dicke mm Epaisseur mm	Masse mm Mesures mm	UVP/Stk. PVC/pce
3080.005	weiss / blanc	4	600 × 1000	29.90
3080.010	weiss / blanc	4	1200 × 1000	59.90
3080.015	grau / gris	4	600 × 1000	29.90
3080.020	grau / gris	4	1200 × 1000	59.90
3080.090	weiss / blanc	10	600 × 1000	54.90
3080.095	weiss / blanc	10	1200 × 1000	109.00

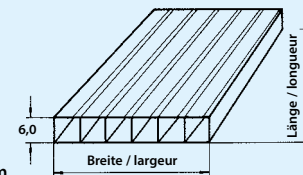

Polycarbonat-Doppelstegplatten glasklar, 6 mm
Plaques doubles à alvéoles, transparent, 6 mm

Art.-Nr. No d'article	Farbe Couleur	Länge mm Longueur mm	Breite mm Largeur mm	UVP/Stk. PVC/pce
0717.110	glasklar / transparent	1250	730	34.90
0717.100	glasklar / transparent	1650	730	44.90
3200.040	glasklar / transparent	750	1050	27.90
3200.034	glasklar / transparent	1500	1050	54.90
3200.033	glasklar / transparent	2000	1050	69.90
3200.031	glasklar / transparent	2500	1050	94.90
3200.015	glasklar / transparent	1000	2100	79.90
3200.012	glasklar / transparent	2000	2100	149.00
3200.005	glasklar / transparent	6000	2100	439.00



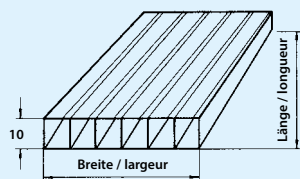

Polycarbonat Doppelstegplatten
glasklar, 10 mm
Plaques doubles à alvéoles, transparent, 10 mm

Art.-Nr. No d'article	Farbe Couleur	Länge mm Longueur mm	Breite mm Largeur mm	UVP/Stk. PVC/pce
3200.053	glasklar / transparent	2000	2100	199.00
3200.050	glasklar / transparent	3000	2100	299.00
3200.045	glasklar / transparent	6000	2100	599.00

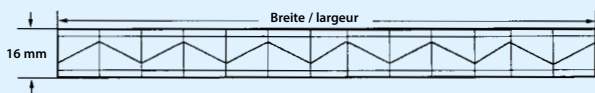

Polycarbonat 7-fach, glasklar, 16 mm, UV-vergütet
Plaques structure 7-fois, transparent, 16 mm, avec protection UV

Art.-Nr. No d'article	Farbe Couleur	Länge mm Longueur mm	Breite mm Largeur mm	UVP/Stk. PVC/pce
3200.213	glasklar / transparent	2000	2100	295.00
3200.210	glasklar / transparent	3000	2100	449.00
3200.205	glasklar / transparent	6000	2100	899.00



Polycarbonat 3-Stegelemente 330/20
Éléments à triple parois en polycarbonat 330/20

Art.-Nr. No d'article	Farbe Couleur	Länge mm Longueur mm	Breite mm Largeur mm	UVP/Stk. PVC/pce
3170.146	glasklar / transparent	1500	333	59.90
3170.147	glasklar / transparent	2000	333	79.90
3170.148	glasklar / transparent	3000	333	119.00

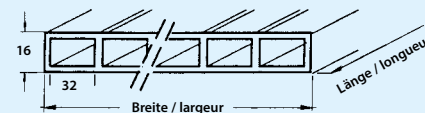

Stegdoppelplatte Plexiglas
16 / 32 / 980
Plaques acryliques Plexiglas
16 / 32 / 980

Art.-Nr. No d'article	Farbe Couleur	Länge mm Longueur mm	Breite mm Largeur mm	UVP/Stk. PVC/pce
3300.005	glasklar / clair	1500	980	149.00
3300.010	glasklar / clair	2000	980	199.00
3300.020	glasklar / clair	3000	980	279.00



Abbildung: Stegdoppelplatte Plexiglas 16/32/980
Image: Plaque acrylique Plexiglas 16/32/980



Abbildung: Polycarbonat 3-Stegelemente 330/20
Image: Éléments à triple parois en polycarbonat 330/20

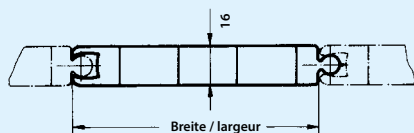



PVC-Doppelwandelemente Nut + Kamm 200/16, transparent
Éléments à double parois en PVC 200/16, transparent, avec rainure et crête



Art.-Nr. No d'article	Farbe Couleur	Länge mm Longueur mm	Breite mm Largeur mm	UVP/Stk. PVC/pce
3160.006	natur / nature	1500	200	13.50
3160.007	natur / nature	2000	200	17.95
3160.008	natur / nature	2500	200	22.90
3160.005	azur / azuré	1500	200	11.95
3160.010	azur / azuré	2000	200	14.95
3160.015	azur / azuré	2500	200	19.50
3160.025	rauchbraun / brun fumé	1500	200	11.95
3160.030	rauchbraun / brun fumé	2000	200	14.95
3160.035	rauchbraun / brun fumé	2500	200	19.50
3160.041	grün / vert	1500	200	17.95
3160.042	grün / vert	2000	200	22.90
3160.043	grün / vert	2500	200	27.90
3160.046	orange / orange	1500	200	17.95
3160.047	orange / orange	2000	200	22.90
3160.048	orange / orange	2500	200	27.90





Profil für Flachplatten 6 mm
Profils pour plaques plates 6 mm

Artikel-Bezeichnung Description d'article	Art.-Nr. No d'article	Länge mm Longueur mm	UVP/Stk. PVC/pce
U-Profil aus Alu Profilé U en alu 	3349.999	750	2.95
	3350.000	1050	3.95
	3350.001	1500	5.95
U-Profil aus Polycarbonat Profilé U en polycarbonate 	3200.510	1050	5.50
	3200.505	2100	8.95
H-Profil aus Polycarbonat Profilé H en polycarbonate 	3200.548	2000	19.95
	3200.540	3000	27.90
	3200.535	6000	54.90



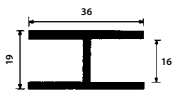
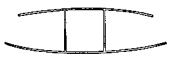
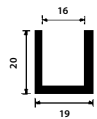

Profil für Flachplatten 10 mm
Profils pour plaques plates 10 mm

Artikel-Bezeichnung Description d'article	Art.-Nr. No d'article	Länge mm Longueur mm	UVP/Stk. PVC/pce
U-Profil aus Polycarbonat Profilé U en polycarbonate 	3200.520	1050	4.95
	3200.515	2100	9.95
H-Profil aus Polycarbonat Profilé H en polycarbonate 	3200.565	1500	17.50
	3200.560	3000	34.90
	3200.555	6000	64.90

Profile für Flachplatten 16 mm
 Profilés pour plaques plates 16 mm

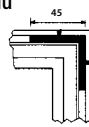
Artikel-Bezeichnung Description d'article	Art.-Nr. No d'article	Länge mm Longueur mm	UVP/Stk. PVC/pce
H-Profil aus Alu Profilé H en alu 	3160.050	1500	8.95
	3160.051	2000	11.95
	3160.052	2500	14.95
	3160.053	3000	18.95
	3160.054	6000	39.90
H-Profil aus Polycarbonat Profilé H en polycarbonate 	3200.585	1500	24.90
	3200.580	3000	49.90
	3200.575	6000	99.90
U-Profil aus Alu Profilé U en alu 	3160.056	1500	6.95
	3160.057	2000	8.95
	3160.058	2500	10.95
	3160.059	3000	12.95
	3160.060	6000	24.90
Eckprofil aus Alu Profilé d'angle en alu 	3160.062	1500	10.50
	3160.063	2000	13.95
	3160.064	2500	16.95
	3160.065	3000	19.95
	3160.066	6000	39.90
Rahmenprofil aus Alu Profilé d'encadrement en alu 	3160.068	1500	12.95
	3160.069	2000	16.95
	3160.070	2500	20.95
	3160.071	3000	24.90
	3160.072	6000	49.90

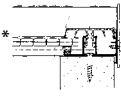
Profile für Flachplatten 16 mm
 Profilés pour plaques plates 16 mm

Artikel-Bezeichnung Description d'article	Art.-Nr. No d'article	Länge mm Longueur mm	UVP/Stk. PVC/pce
Eckverbindungswinkel aus Alu Cornière de jonction en alu Set à 4 Stk./pces 	3160.074		4.95
Profilsprosse aus Alu inkl. PVC-Deckleiste und Gummidichtung* Profilé d'assemblage en alu avec profilé de recouvrement en PVC* 	3320.054	7000	199.00
Randprofilsprosse aus Alu inkl. PVC-Deckleiste* Profilé d'assemblage de bordure en alu avec profilé de recouvrement en PVC* 	3320.064	7000	249.00
U-Profil aus Polycarbonat Profilé U en polycarbonate 	3200.591	1050	4.95
	3200.592	2100	9.95

* Für Plattenstärken 6/10 + 16 mm

* Pour plaques 6/10 + 16 mm

Profile für Flachplatten 20 mm
 Profilés pour plaques plates 20 mm

Artikel-Bezeichnung Description d'article	Art.-Nr. No d'article	Länge mm Longueur mm	UVP/Stk. PVC/pce
Rahmenprofil aus Alu Profilé d'encadrement en alu	3170.310	2000	19.95
	3170.325	6000	59.90

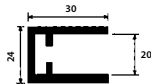

Winkelprofile
 Profilés cornières

Artikel-Bezeichnung Description d'article	Art.-Nr. No d'article	Länge mm Longueur mm	UVP/lm PVC/lm
Winkelprofile Alu, gleichschenkelig Profilé cornières alu, à ailes égales alu	0728.542	50 / 50 / 2	12.95

Lagerlänge / Longueur
ca. 6000 mm

Universalprofil aus Alu, zu Flachplatten 2–10 mm
 Profilé universel en alu, pour plaques de 2–10 mm

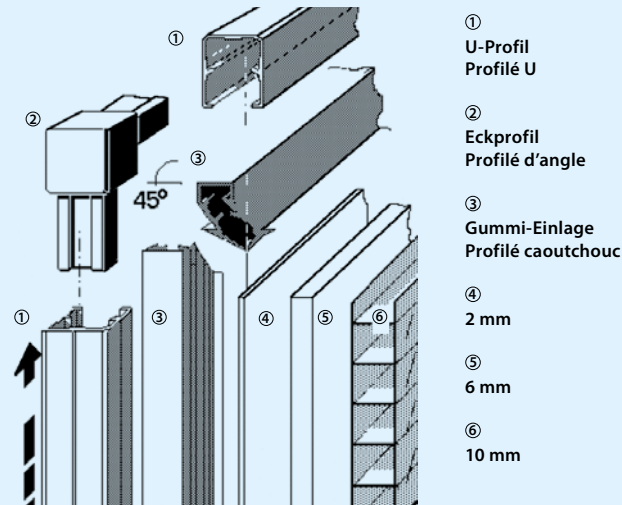



- ① U-Profil
Profilé U
- ② Eckprofil
Profilé d'angle
- ③ Gummi-Einlage
Profilé caoutchouc
- ④ 2 mm
- ⑤ 6 mm
- ⑥ 10 mm

Artikel-Bezeichnung Description d'article	Art.-Nr. No d'article	Länge mm Longueur mm	UVP/Stk. PVC/pce
U-Universalprofil 2–10 mm, inkl. Gummieinlage Profilé universel U 2–10 mm, incl. caoutchouc	3160.110	475	12.50
	3160.111	975	17.50
	3160.112	1975	27.90
Eckprofil Profilé d'angle Set à 4 Stk./pces	3160.119	PC	7.50

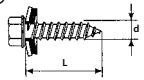
Befestigungsmaterial für Wellplatten Matériel de fixation pour plaques ondulées





Artikel-Bezeichnung Description d'article	Art.-Nr. No d'article	Dimension Dimension	Packung à Stk. Paquet à pces	UVP/Stk. PVC/pce
Plastik-Rondelle bombiert, mit U-Scheibe Rondelle plastique bombée, avec rondelle 	3400.042	20 × 6	10	2.95
Fabco-Schrauben für Holz mit Dichtscheibe Stahl 18/8 S 19 Vis Fabco pour bois Rondelle d'étanchéité acier 18/8 S 19 	3400.142	6,5 × 51	250	149.00

Befestigungsmaterial für Wellplatten Matériel de fixation pour plaques ondulées



Artikel-Bezeichnung Description d'article	Art.-Nr. No d'article	Dimension Dimension	Packung à Stk. Paquet à pces	UVP/Stk. PVC/pce
Stützbügel S 70/18 Support S 70/18 	3400.011	S 70/18	10	2.95
Stützbügel 76/18 Support 76/18 	3400.026	76/18	10	3.50
Stützbügel 177/51 Support 177/51 	3400.088	177/51	25	12.95

Befestigungsmaterial für Wellplatten Matériel de fixation pour plaques ondulées



Artikel-Bezeichnung Description d'article	Art.-Nr. No d'article	Packung à Stk. Paquet à pces	UVP/Stk. PVC/pce
Befestigungs-Set für Wellung S 70/18: Holzschrauben verz. 5 × 50 Metall-U-Scheiben verz. 5 × 15 × 1 Spezial-Rondellen weiss Set de fixation pour ondulation S 70/18: <i>vis à bois galv. 5 × 50</i> <i>rondelles galv. 5 × 15 × 1</i> <i>rondelles spéc. blanche</i> 	3400.005	20	7.50
Befestigungs-Set für Wellung 76/18: Holzschrauben verz. 5 × 50 Metall-U-Scheiben verz. 5 × 15 × 1 Plastik-Rondellen bombiert Set de fixation pour ondulation 76/18: <i>vis à bois galv. 5 × 50</i> <i>rondelles galv. 5 × 15 × 1</i> <i>rondelles plastiques bombées</i> 	3400.020	20	6.95
Befestigungs-Set für Wellung NP 65: Fabco-Schrauben für Holz 76 × 18 und Trapez Dichtscheiben S.19 Set de fixation pour ondulation NP 65: <i>vis Fabco pour bois 76 × 18 et trapèze</i> <i>rondelles d'étanchéité S.19</i> 	3400.045 3400.046	20 10	13.50 6.50
Befestigungs-Set für Wellung 177/51: Holzschrauben verz. 7 × 90 Metall-Rondellen verz. 25 × 7 Gummi-Rondellen Set de fixation pour ondulation 177/51: <i>vis à bois galv. 7 × 90</i> <i>rondelles galv. 25 × 7</i> <i>rondelles caoutchouc</i> 	3400.087	20	9.95

Befestigungsmaterial für Wellplatten Matériel de fixation pour plaques ondulées

Artikel-Bezeichnung Description d'article	Art.-Nr. No d'article	Länge mm Longueur mm	UVP/Stk. PVC/pce
Dichtungsstreifen S 70 / 18 Bande d'étanchéité S 70/18 	3400.018	1050	4.50
Dichtungsstreifen 76 / 18 Bande d'étanchéité 76/18 	3400.036	850	4.50
Artikel-Bezeichnung Description d'article	Art.-Nr. No d'article	Inhalt Capacité	UVP/Stk. PVC/pce
PVC-Kleber Colle pour PVC 	0871.610	250 ml	21.90

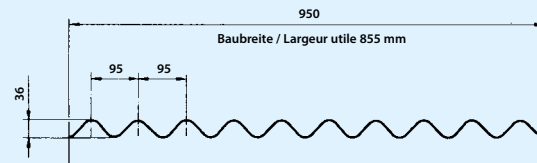

Onduline Bitumen-Wellplatten, Wellung 95 / 36 Onduline plaques ondulées en bitumen, Ondulation 95 / 36

Art.-Nr. No d'article	Farbe Couleur	Länge mm Longueur mm	Breite mm Largeur mm	UVP/Stk. PVC/pce
3150.022	braun / brun	2000	855	23.90
3150.024	grün / vert	2000	855	23.90
3150.023	rot / rot	2000	855	23.90
3150.021	schwarz / noir	2000	855	23.90

Tipp:
Möchten Sie transparente Elemente in Ihre Bitumen-Bedachung einbauen?
Passende Elemente hierfür finden Sie auf der Seite 4 (Polyesterplatten 95/37).

Conseil:
Vous souhaitez installer des éléments transparents dans votre toiture en bitume ?
Les éléments appropriés se trouvent à la page 4 (plaques en polyester 95/37).

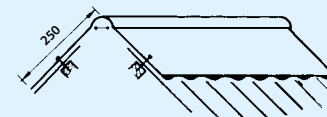

Onduline Firststücke Faitières Onduline

Art.-Nr. No d'article	Farbe Couleur	Länge mm Longueur mm	Breite mm Largeur mm	UVP/Stk. PVC/pce
3150.050	braun / brun	900	500	10.95
3150.055	grün / vert	900	500	10.95
3150.060	rot / rot	900	500	10.95
3150.065	schwarz / noir	900	500	10.95

Schindeln-Rechteck
Bardeaux rectangulaires

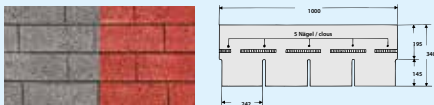

Art.-Nr. No d'article	Farbe Couleur	Packung à Stk.* Paquet à pces*	UVP/Stk. PVC/pce
3150.195	braun / brun	14	29.95
3150.194	schwarz / noir	14	29.95

*Ein Paket deckt 2 m² Dachfläche. / Un paquet couvre 2 m² de toiture.

Schindeln-Biberschwanz
Bardeaux Biber

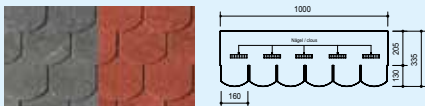

Art.-Nr. No d'article	Farbe Couleur	Packung à Stk.* Paquet à pces*	UVP/Stk. PVC/pce
3150.192	rot / rouge	14	29.95
3150.191	schwarz / noir	14	29.95

*Ein Paket deckt 2 m² Dachfläche. / Un paquet couvre 2 m² de toiture.

Befestigungsmaterial für Bitumenplatten
Matériel de fixation pour plaques bitumen

Artikel-Bezeichnung Description d'article	Art.-Nr. No d'article	Länge mm Longueur mm	Packung à Stk. Paquet à pces	UVP/Stk. PVC/pce
Stützbügel für Onduline Support pour Onduline	3150.072		5	1.95
Onduline Nägel Clous Onduline	3400.049	70	20	2.95
Dichtungstreifen für Onduline Bande d'étanchéité pour Onduline	3400.056	860	1	5.95
Bardoline-Tegola-Befestigungsstifte, verzinkt Clous fixation Bardoline-Tegola, galvanisé	3400.060		100	4.50

DACHRINNE · GOÜTTIÈRE



Art.-Nr. No d'article	Beschreibung Description	UVP/Stk. PVC/pce
0812.213	Dachrinne Set 1, beidseitig 3 m <i>Kit gouttière 1, deux côtés, 3m</i>	269.00
0812.216	Dachrinne Set 2, beidseitig 4 m <i>Kit gouttière 2, deux côtés, 4 m</i>	329.00
0812.202	Dachrinnen-Verlängerung, 2 m <i>Prolongation de gouttière, 2 m</i>	150.00

grischa silva  Holz
Lenn
Legno

- Zaunbau
- Gartenhäuser
- Sichtschutz
- Terrassenböden

www.grischa-silva.ch

Waldau - 7302 Landquart / Tel. 081 322 60 05

grischa silva  Holz
Lenn
Legno

www.grischa-silva.ch
Waldau - 7302 Landquart / Tel. 081 322 60 05

• Zaunbau • Gartenhäuser • Sichtschutz • Terrassenböden • Gartenmöbel • Spielplatzgeräte

0100.017 - 04/19 Modell- und Preisänderungen vorbehalten.

Alle genannten Preise verstehen sich als unverbindliche Verkaufspreise (UVP), exkl. Transport. Gedruckt in der Schweiz.

04/19 Sous réserve de changement de modèle et de prix. Tous les prix imprimés sont des prix de vente conseillé (PVC). Sans frais de transport. Imprimé en Suisse.